

D-Torch* installation guide

Optima 2/4/5/7000DV

30-808-2926



BEFORE YOU START

Congratulations on the purchase of your D-Torch.

As supplied, the D-Torch is fully assembled. Table 1, lists the D-Torch parts that can be ordered separately.

The D-torch is supplied with a pair of gloves; always wear clean gloves when handling ICP Torches and their components

Item No.	Part Number	Description	Qty
1	31-808-2981	D-TORCH OPTIMA 2/4/5/7000DV BODY	1
2	31-808-2986	D-TORCH OPTIMA 2/4/5/7000DV QUARTZ OUTER TUBE	1
3	31-808-2818	Retainer	1
4	2491	HEX KEY 2.5mm	1
5	SAFEGLOVE-MED	Safety Gloves	1

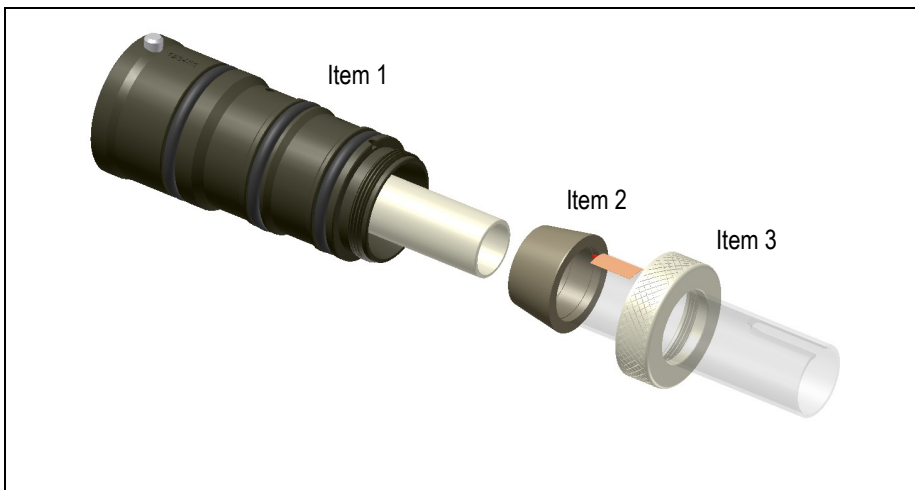

A. SCOPE

This document will explain how to perform the following operations: -

1. Installation of D-Torch to Optima DV ICP
2. Removal of D-Torch Outer Tube
3. Replacement of D-Torch Outer Tube

B. TOOLS, SPECIAL REQUIREMENTS, etc

- Phillips Screw Driver - #2 Point
- Hex Key - 2.5mm (Item 4 Supplied)
- Safety gloves (Item 5 Supplied)

C. PRECAUTIONS FOR PERSONAL SAFETY AND TORCH PRESERVATION

- Always wear safety gloves (item 5) and glasses when removing (or replacing) ICP Torches.
- The D-Torch is made from high grade engineered materials – Handle with extreme care
- Do not allow the D-Torch to be placed on hard surfaces or allow it to come into contact with hard objects
- It is recommended you review and understand this procedure before handling the D-Torch assembly.

* The D-Torch is covered by US Patent 8,232,500 B2

D-Torch* installation guide

Optima 2/4/5/7000DV

30-808-2926

1. INSTALLING GLASS EXPANSION D-TORCH TO OPTIMA DV ICP

- 1.1 Disconnect (if fitted) the Spray chamber and remove it from ICP torch Coupler.
- 1.2 Remove the torch Coupler from your ICP.
- 1.3 Unscrew the Locking lug (in two places) from Coupler using a Phillips head screwdriver.



Step 1.1

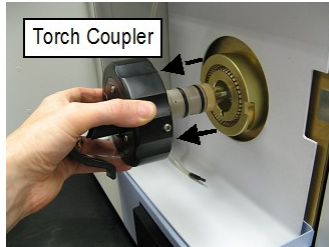

Step 1.2



Step 1.3

- 1.4 Remove the three screws retaining the Coupler end-plate using a Phillips head screwdriver.
- 1.5 Carefully remove the Coupler end-plate.
Note! To prevent the internal spring from being lost, keep Injector fitted to the Coupler end-plate.
- 1.6 Remove the three screws retaining the ICP Torch using the 2.5mm hex Key provided (item 4).



Step 1.4

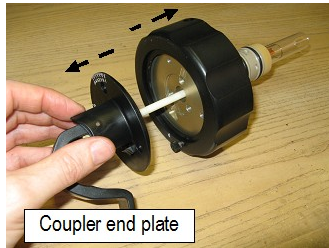

Step 1.5

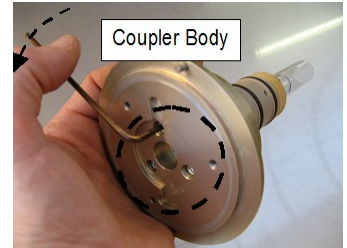

Step 1.6

- 1.7 Remove the original Torch from the Coupler body, fit the D-Torch and fasten in place using the screws from step 1.6

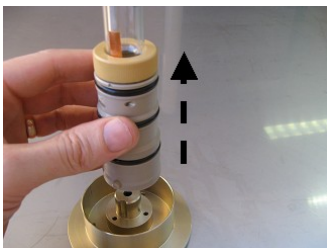

Step 1.7a

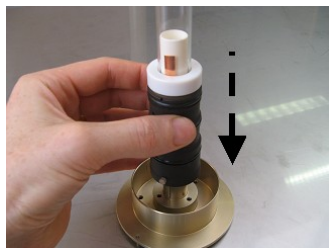

Step 1.7b

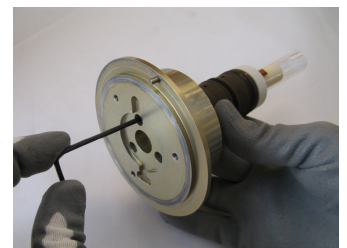

Step 1.7c

Be careful not to 'cross-thread' the screws. Fit all three screw loosely to begin with then tighten progressively in a clockwise fashion. If a screw feels tight at the beginning, **do not** force-it. Remove the screw and then try again.

- 1.8 Finish reassembling the Coupler by completing steps 1.3 to 1.6 in reverse order.

Note! When reassembling the Torch coupler, check for the following: -

- When fitting the Coupler housing, the pin of the Coupler body must sit in the slot shown below.
- Before screwing on the Coupler end-plate, check that the indicator symbols are close to the Housing 'tear drop'

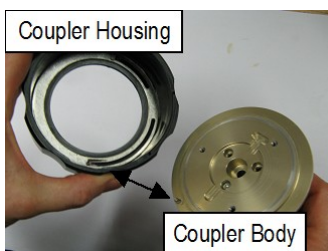

Step 1.8a



Step 1.8b



Finished

Finished After the Coupler has been reassembled, it can be returned to your ICP - Ready for use.

D-Torch* installation guide

Optima 2/4/5/7000DV

30-808-2926

2. REMOVAL OF D-TORCH OUTER TUBE

The D-Torch's outer tube is accurately located in the D-Torch body with a retainer cap. The outer tube can be removed at any time by completing the steps below.

- 2.1 If fitted, remove Torch assembly from ICP. (Not Shown)
- 2.2 Unscrew retainer ½ turn.
- 2.3 Grip outer tube (lower end, near D-Torch body) then gently wriggle the outer tube from side to side. You will hear a “click” as the outer tube releases from the D-Torch body.
- 2.4 Fully unscrew the Retainer then carefully withdraw the Outer Tube from the Torch Body.



Step 2.2

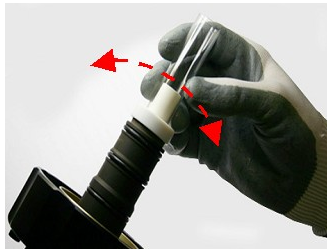

Step 2.3

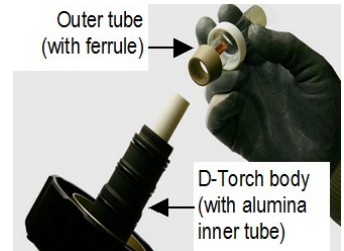

Step 2.4

Note! Outer tube is permanently fitted with a tapered ferrule - **Do not** attempt to remove ferrule from outer tube.
Inner tube is permanently fixed to D-Torch body - **Do not** attempt to remove inner tube from D-Torch body.

3. REPLACEMENT OF D-TORCH OUTER

To replace the outer Tube, complete the following steps.

- 3.1 Check that both locating surfaces (Outer Tube and Torch body) are clean and free of damage.

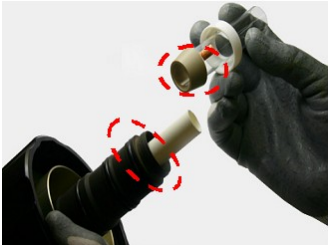

Step 3.1

- 3.2 Carefully slide the Outer Tube over the Inner Tube – The Outer Tube will self locate into the Torch body.
Note! You must align the D-Torch body's red-dot with the inner tube's hole - Visible under the copper foil.

- 3.3 Reattach the retainer to the D-Torch body to fix the outer tube in place (moderate force by hand is adequate).



Step 3.2a

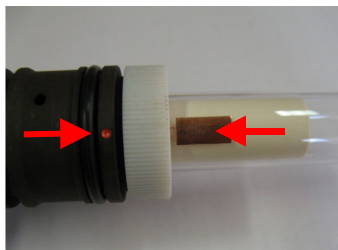

Step 3.2b



Step 3.3

- 3.4 Return Torch assembly to ICP and connect as normal. (Not Shown)

Note! If you have any questions regarding your D-Torch or this procedure, please contact your supplier